

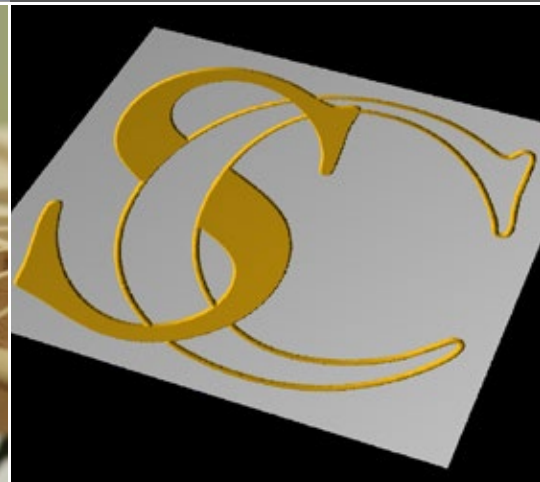

Gravostyle™ Levels & Options

Unique software for
mechanical and laser
engraving machines



GRAVOSTYLE
SOFTWARE SOLUTION

LEVELS OVERVIEW

Gravostyle™ is available from Explorer to 3D levels, thus offering a wide range of business functions adapted to different sectors of activity.

Functions accumulate over the levels.

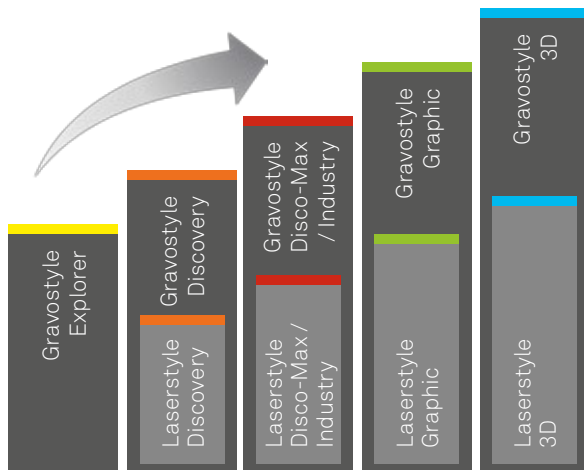

Through the electronic licence system, users can easily update their software online.

Functionalities available at all levels:

- Practical and intuitive interface
- Personalisation of the work space
- Step-by-step function assistance
- Interactive and dynamic help with videos
- Machine accessories management: cylinder attachment and automatic plate feeder (APF) etc.
- Compatibility with True Type fonts
- Management of left/right and top/bottom script
- Engraving parameters saved with the job
- Zoom, print, grid and guide-line functions

LEVELS >

Explorer

[mechanical]

Discovery

[mechanical + laser]

Essential lettering capabilities

Go hybrid
Drive laser & rotary technology



CHARACTERISTICS

- Import of vector files (DXF, EPS, HPGL etc.) and images (BMP, JPG, PNG and TIF etc.)
- Plate Point & Shoot: makes it possible to define the engraving area directly with the machine
- Standard text functions
- Automatic centering function and centering texts on the plate
- Pre-routed engraving fonts
- Extensive choice of symbols
- Intuitive management of toolpaths by colour with advice on the choice of tools
- On-screen preview

- Duplication of plates and lists of variables
- Management of plans
- PDF import and file export (PDF, DXF, EPS, HPGL etc.)
- Alignment and conversion tools
- Geometric shapes
- Laser control capacity using predefined parameters
- Calibration: simplified discovery of engraving parameters for new laser materials

OPTIONS

Personalisation pack:

- Photograph processing Dedicace™ freehand drawing
- Additional pre-routed engraving fonts

- Braille production
- Font editor

★ APPLICATIONS

- Badges, letter box plaques and door plaques
- Photograph engraving
- Jewellery and gifts
- Pens
- Pet tags, key rings
- Ornamental plaques
- Labels for valves and pushbuttons

- Engraving of plates with automatic serial numbering
- List of variabilised names
- Small signage
- Funeral plaques
- Rubber stamps

DiscoveryMax / Industry

[mechanical + laser]

Graphic

[mechanical + laser]

3D

[mechanical + laser]

DiscoveryMax
Productivity pack

Industry
Power, precision and productivity

Unleash your creativity

Take your engraving to a new dimension



- Scanning and vectorisation
- Point mode and bitmap editor
- 2D filling by colour
- Personalisation
- Font pack (over 100 fonts)
- Scripts (automated functions)

- Dials and scales
- Scripts (macro functions)
- Long plate
- Measurement tools
- Batch import function
- Import of external data (CSV, TXT, Excel, SQL, ODBC etc.)
- Shape duplication tools

- Nesting (material usage optimisation)
- CAM module (advanced tool management)
- Powerful on-screen simulation and rendering
- Advanced Braille toolpath management
- Print & Cut module
- LED positioning module
- Laser photograph engraving module
- Cutter (die, etc)
- Shading (3D effect)

- Surface design and manipulation tools
- Styl'Art 3D model module
- 3D texture
- Sculpting tool
- 3D CAM toolpath management
- 3D preview tools
- All 2.5D functions included as standard

- Text on a shape

- Barcodes, Datamatrix™, QR code and UID - unique identification with management of variables

- 2.5D toolpath for jewellery, punches and intaglio for signage
- Laser toolpaths for deep marking

- Scanning and engraving of logos
- Trophies, awards and giftware
- Plaques with texts and logos
- Labels, plaques and signage with text, symbol or logo

- Machine plates
- Front panels
- Identification and traceability parts
- Printed circuits
- Linear and 2D barcodes
- Laser cutting of paper and cardboard

- Laser photograph engraving
- Model making
- Marquetry
- Design and production of trophies
- Cutting out of printed signage
- Trade sign design

- 3D signage
- Display stands
- Embossing dies
- Industrial moulds
- Furniture decoration
- Models and prototypes
- Trophies and awards
- Commemorative plaques

EXPLORER LEVEL

Badges, letter box plaques and door plaques, photograph engraving, jewellery and gift market, pen, pet tags, key rings, ornamental plaques, labels for valves and push buttons...

KEY FUNCTIONS

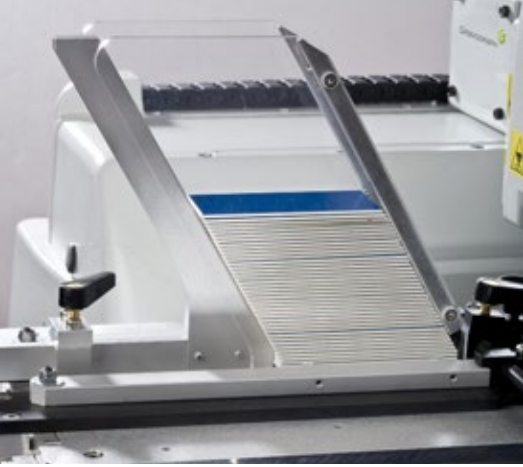

Accessories management



Plate Point & Shoot



Automatic text centring



Symbols library

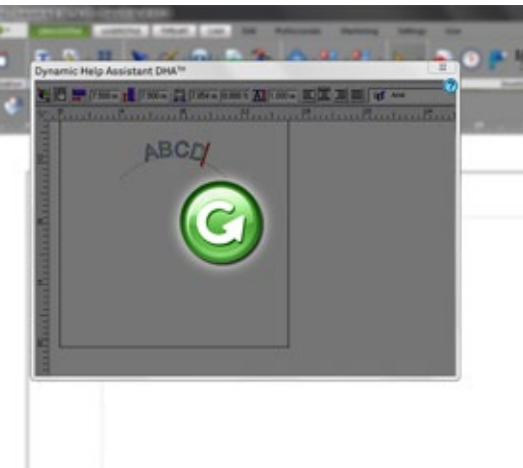

DHA™ (Dynamic Help Assistant) how to video



Computip: help for choosing the best tool

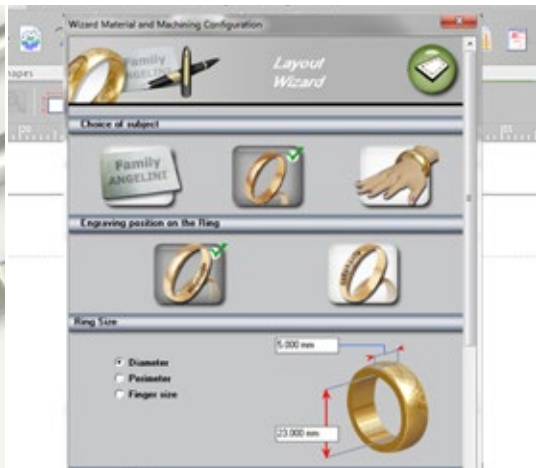

Step-by-step function wizards

OPTIONS



Photostyle +
Bitmap editor

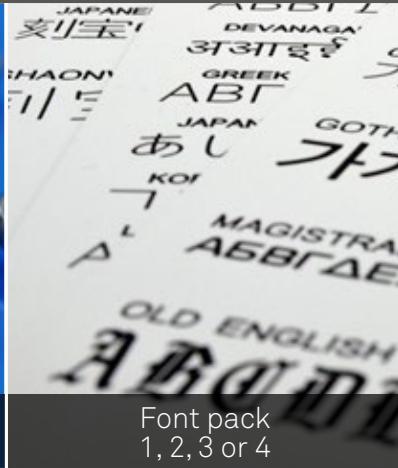

Font pack
1, 2, 3 or 4



Dedicace™

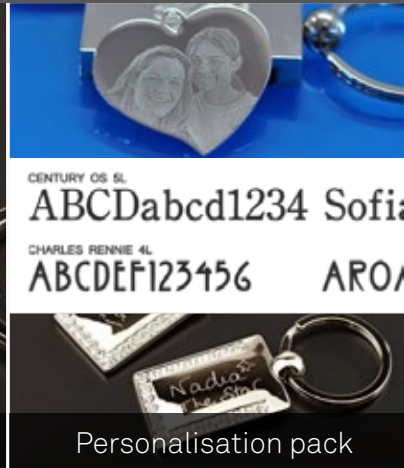

Personalisation pack

MAIN RIBBONS

Gravostyle ribbon

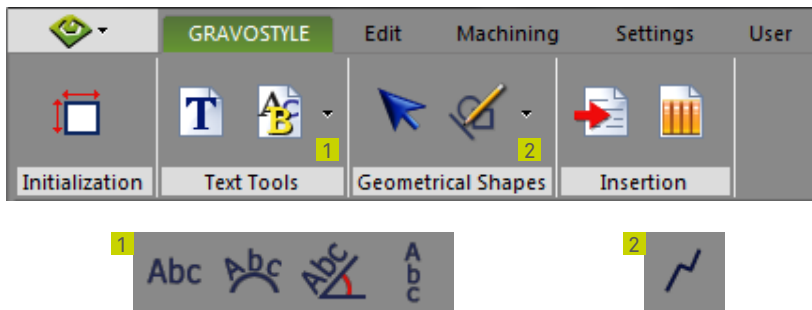

Edit ribbon

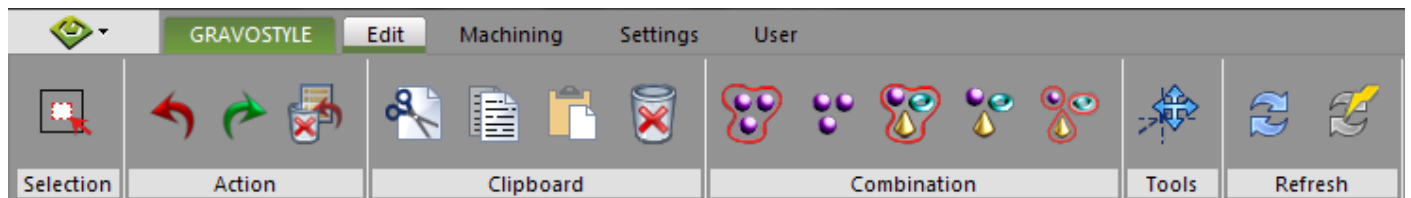

DISCOVERY LEVEL

Engraving of multi-plates with variable information and serial numbering, small signage, personalised gifts and awards, rubber stamps and more

KEY FUNCTIONS

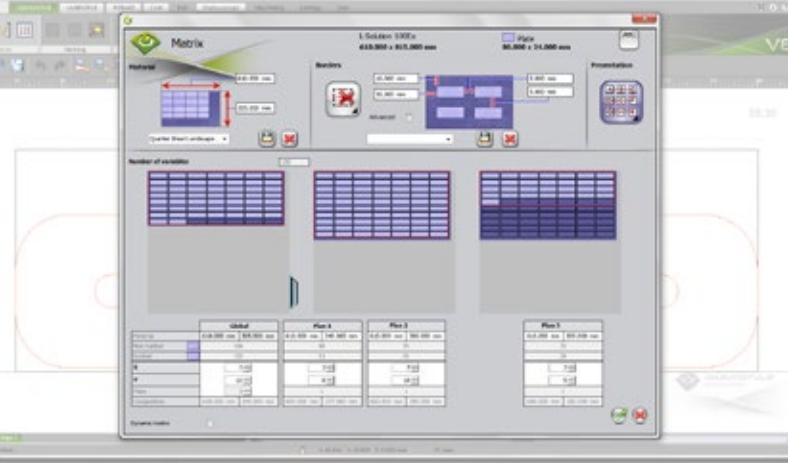

Matrix

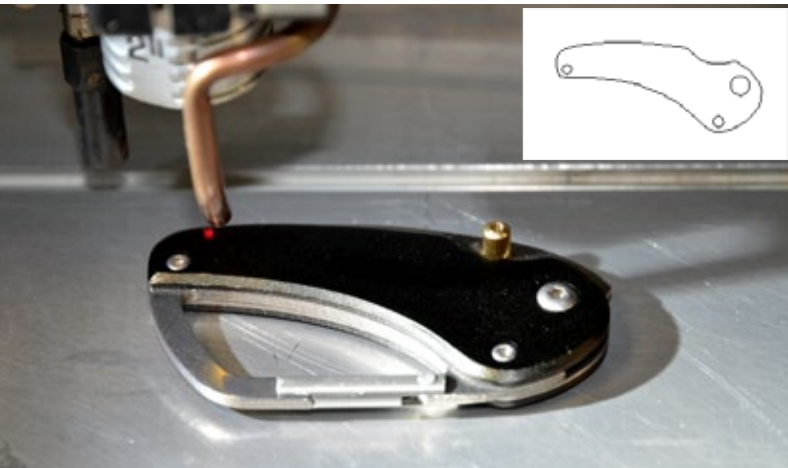

Line Point & Shoot

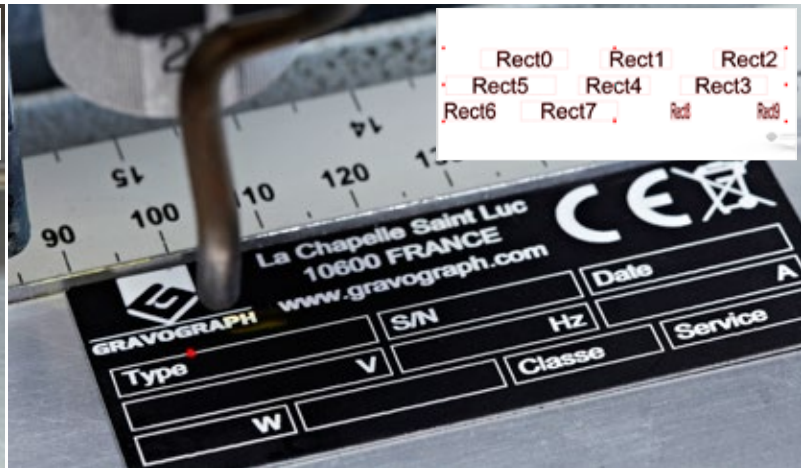

Text in a rectangle Point & Shoot

LASERSTYLE™ KEY FUNCTIONS



Rubber stamp



Engraving database of parameters



Laser settings calibration wizard

OPTIONS

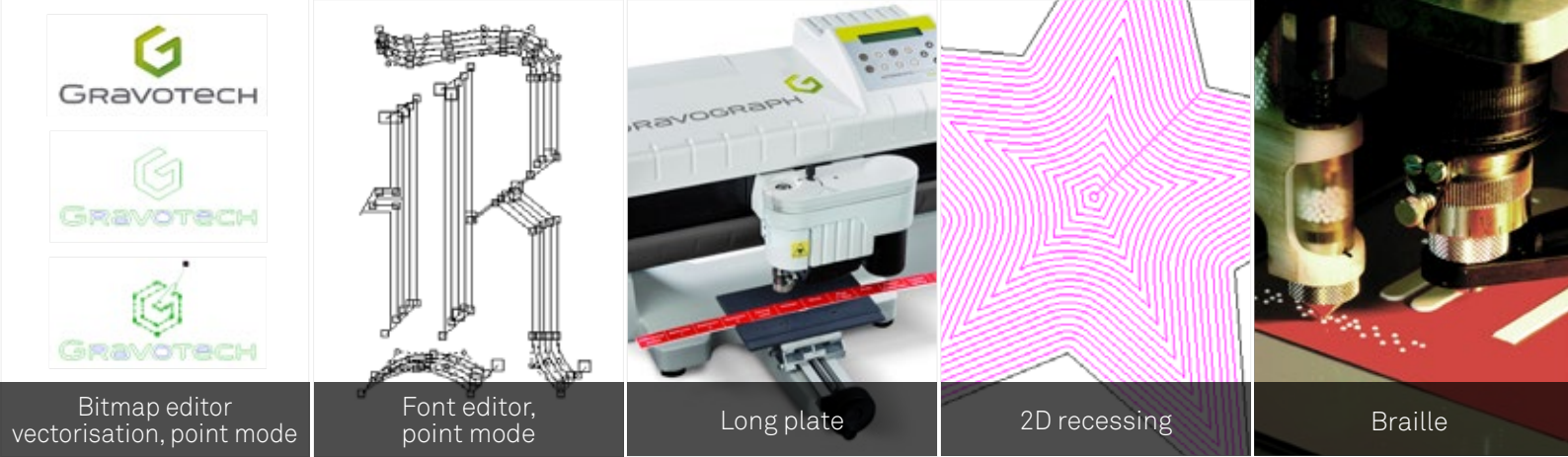

OTHER AVAILABLE OPTIONS

- Dedicace™
- Font pack 1, 2, 3 or 4
- Personalisation pack
- Photostyle + Bitmap editor

MAIN RIBBONS

Gravostyle ribbon

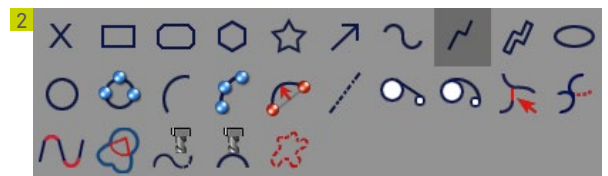
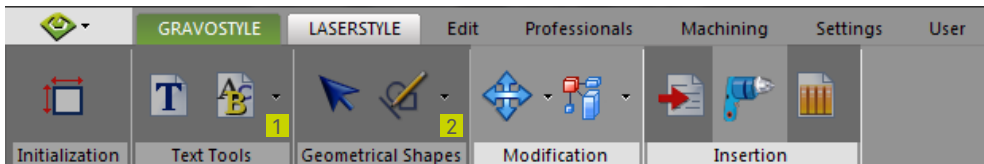

Edit ribbon



Professional tools ribbon

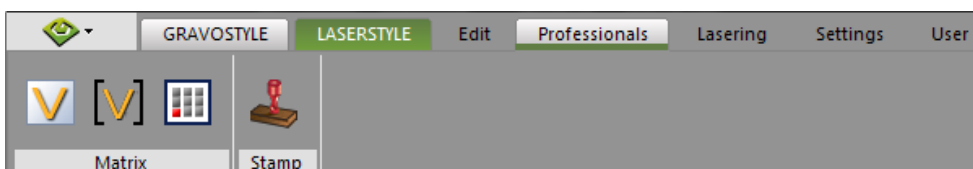

DISCOVERY MAX LEVEL

Scanning, editing and infilling of text, symbols and logos with added productivity tools

KEY FUNCTIONS



Bitmap editor



Vectorisation



Point mode

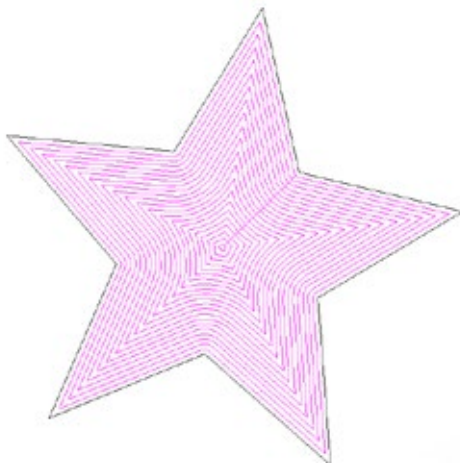

2D recessing



Font pack 3



Custom software service (script)

LASERSTYLE™ KEY FUNCTIONS

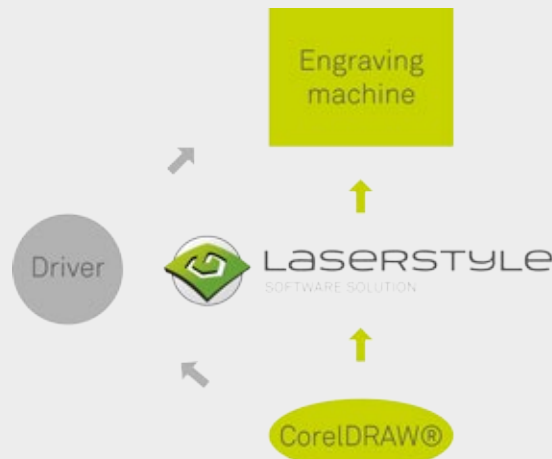

Direct link with CorelDRAW®

OPTIONS



curved text

OTHER AVAILABLE OPTIONS

- Braille
- Dedicace™
- Font editor
- Long plate
- Font pack 1, 2 or 4

- Personalisation pack
- Photostyle

MAIN RIBBONS

Gravostyle ribbon

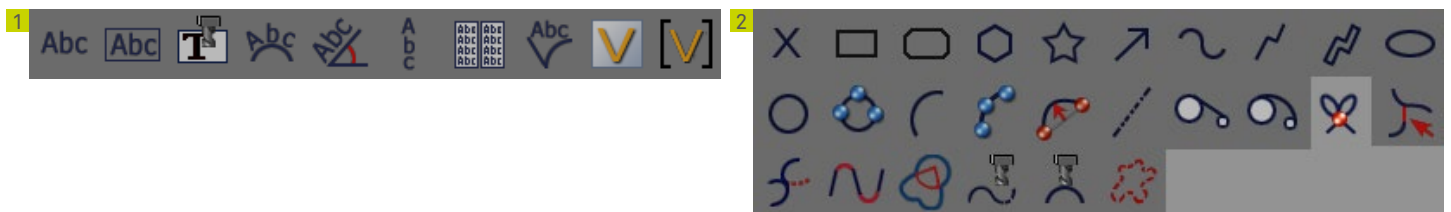
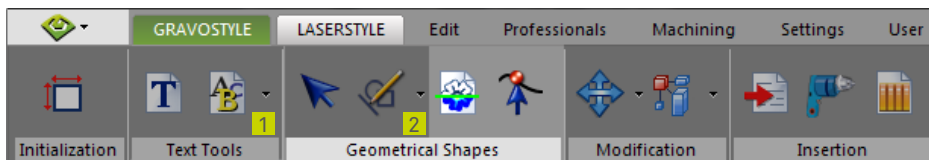

Edit ribbon

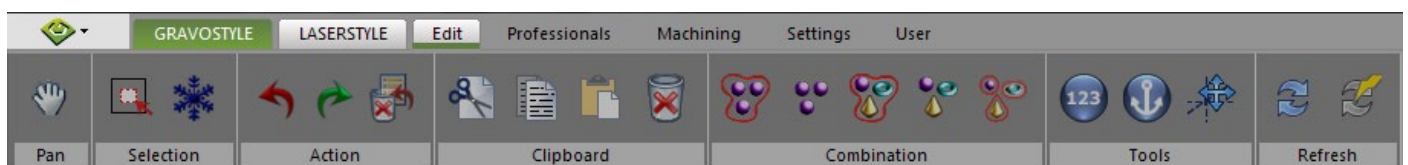

Professional tools ribbon



INDUSTRY LEVEL

Machine plates, front panels, identification and traceability parts, printed circuits, linear and 2D barcodes, laser cutting of paper and cardboard, and more...

KEY FUNCTIONS

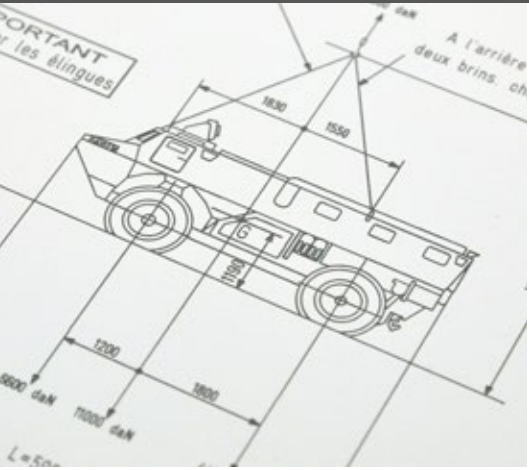

Measurement tools

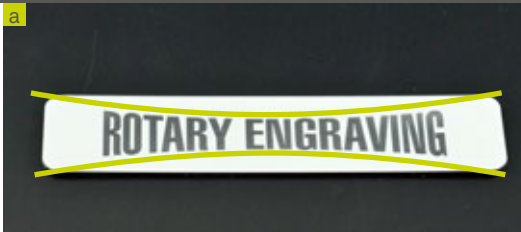

a Envelope

b Duplication on a curve

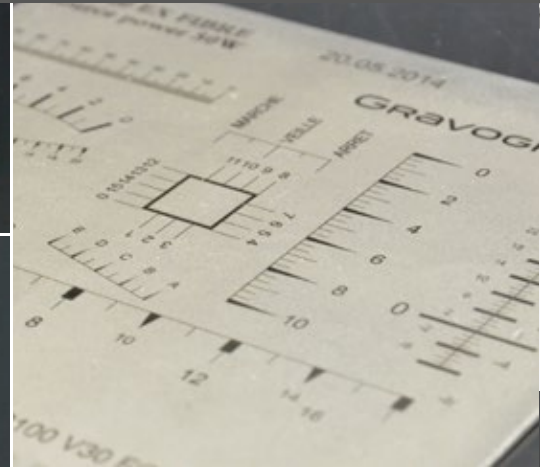

Scales and dials

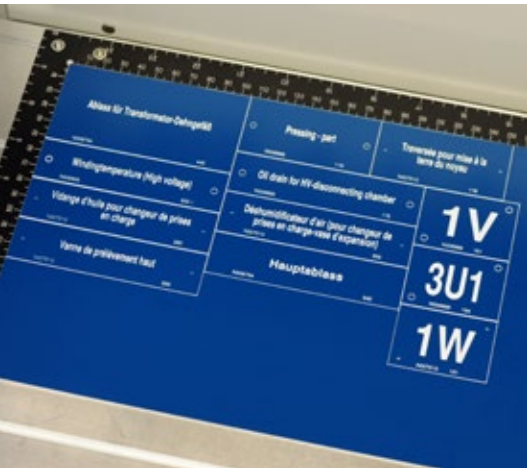

Grouped import



Interface with external data sources



Long plate

LASERSTYLE™ KEY FUNCTIONS

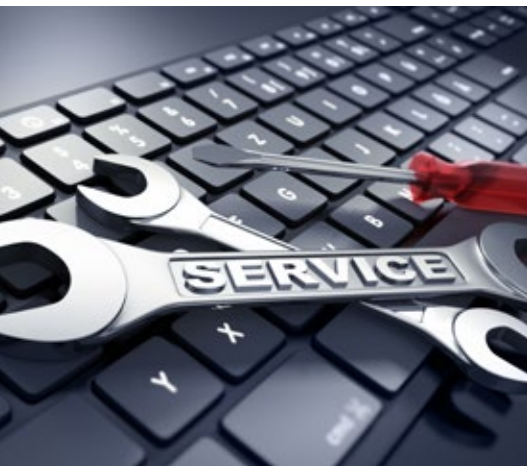

Custom software service (script)



Tangential In and Out

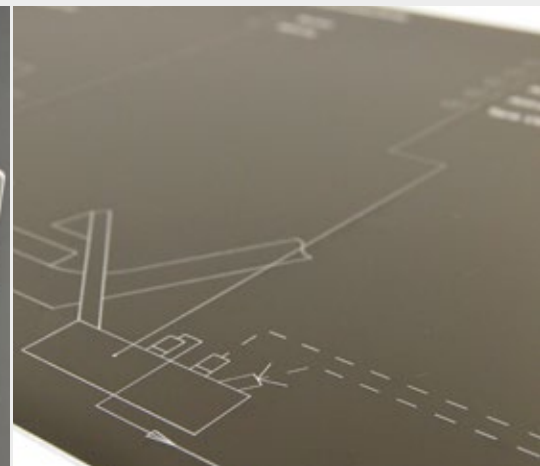

Dotted line and arrows

OPTIONS

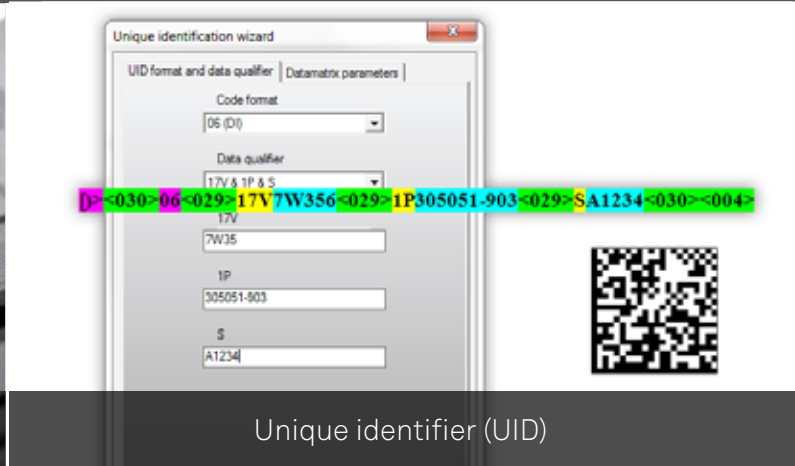

OTHER AVAILABLE OPTIONS

- Braille
- Dedicace™
- Font editor + Point mode
- 2D recessing
- Font pack 1, 2, 3 or 4

- Personalisation pack
- Photostyle + Bitmap editor
- Vectorisation + Bitmap + Point mode

MAIN RIBBONS

Gravostyle ribbon

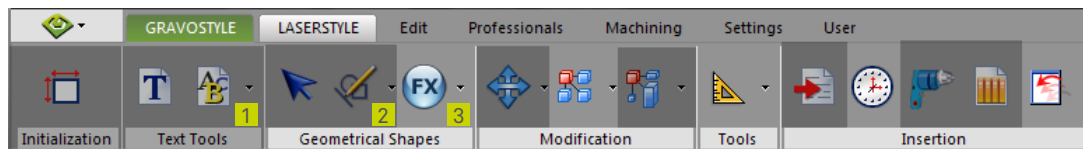

Edit ribbon

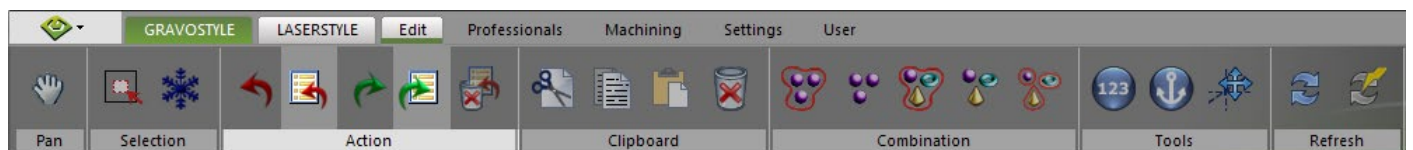

Professional tools ribbon

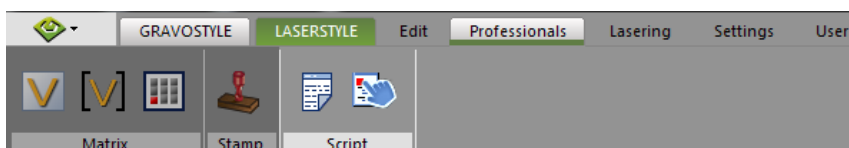

GRAPHIC LEVEL

All productivity tools included: advanced CAD-CAM module and tool database, laser photograph engraving, automatic material nesting, Print & Cut function and more...

KEY FUNCTIONS



Shadowing



Automatic Nesting + Nesting Pro + Magic Copy



LED



Print & Cut



Rotary CAM

LASERSTYLE™ KEY FUNCTIONS

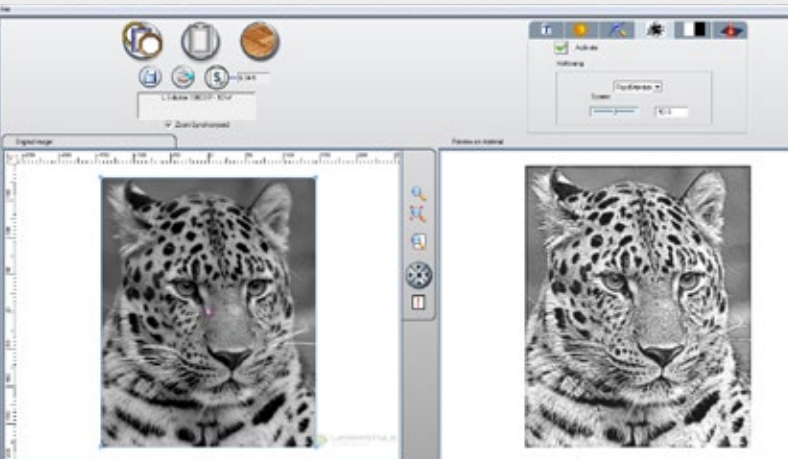

Photolase

OPTIONS



OTHER AVAILABLE OPTIONS

- Braille
- Barcodes, Datamatrix™, QR Code
- Dedicace™
- Font editor
- Unique identifier (UID)
- Font pack 1, 2, 3 or 4
- Personalisation pack
- Photostyle

MAIN RIBBONS

Gravostyle ribbon

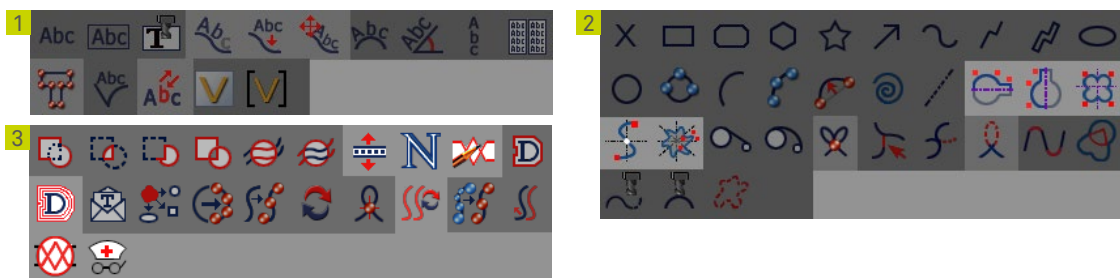
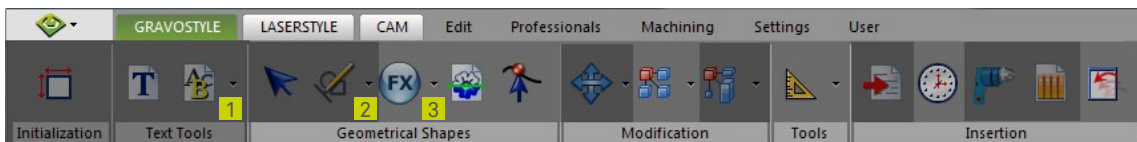

CAM ribbon

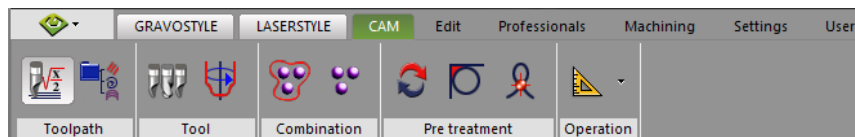

Edit ribbon

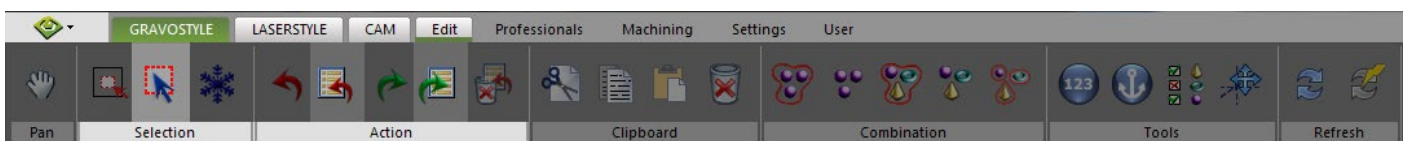

Professional tools ribbon

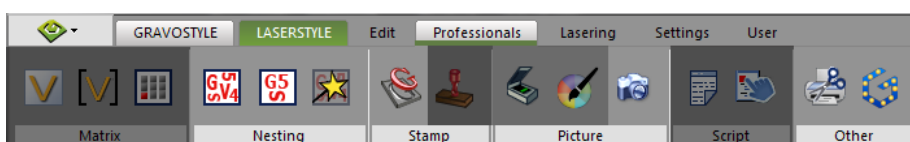

3D LEVEL

3D signage, display stands, embossing dies, food-grade moulds, furniture decoration, models and prototypes, trophies and awards, commemorative plaques, and more...

KEY FUNCTIONS



Type Art



Surface projection

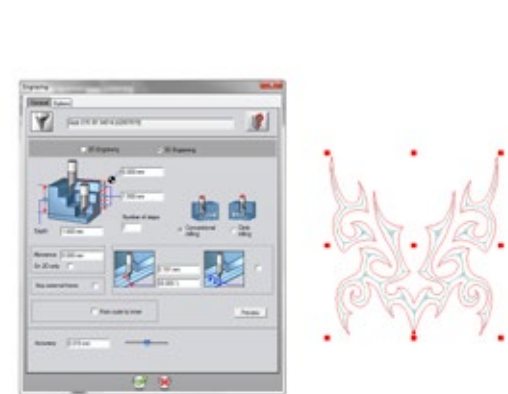

2.5D



Intaglio

LASERSTYLE™ KEY FUNCTIONS



3D texture

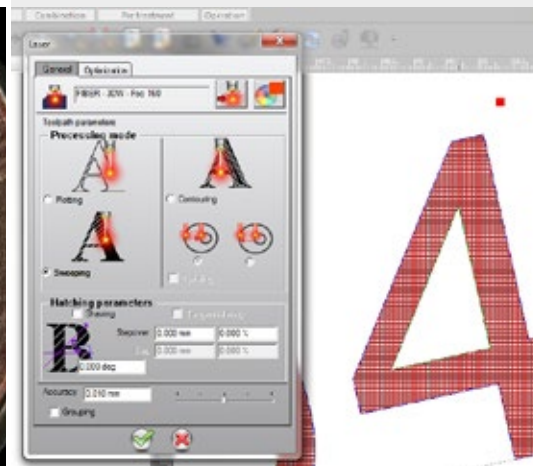

Laser CAM



OPTIONS

OTHER AVAILABLE OPTIONS

- Braille
- Barcodes, Datamatrix™, QR Code
- Dedicace™
- Font editor
- Unique identifier (UID)
- Font pack 1, 2, 3 or 4
- Personalisation pack
- Photostyle

MAIN RIBBONS

Gravostyle ribbon



TypeArt ribbon - part 1

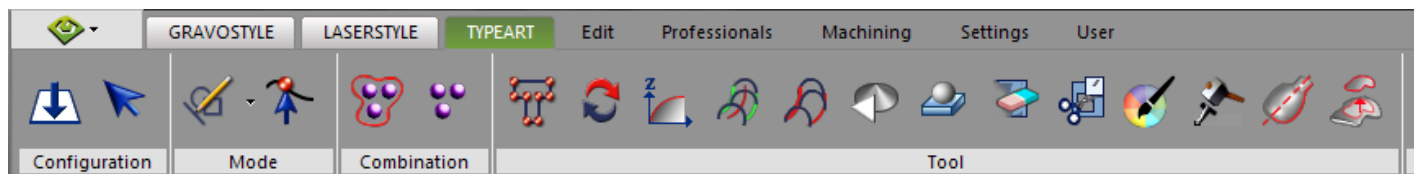

TypeArt ribbon - part 2

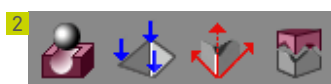
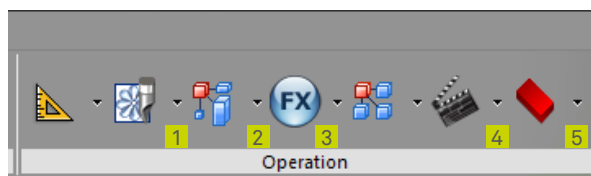



LIST OF REFERENCES

Gravostyle™ 8 Upgrades	
Explorer Upgrades	
77460	EXPLO-DISCO GS8 UPGRADE
77461	EXPLO-DISCO MAX GS8 UPGRADE
77463	EXPLO-INDUS GS8 UPGRADE
77462	EXPLO-GRAPH GS8 UPGRADE
77458	EXPLO-3D GS8 UPGRADE
Discovery Upgrades	
77451	DISCO-DISCO MAX GS8 UPGRADE
77456	DISCO-INDUS GS8 UPGRADE
77454	DISCO-GRAPH GS8 UPGRADE
77446	DISCO-3D GS8 UPGRADE
Discovery Max Upgrade	
77444	DISCO MAX-GRAPH GS8 UPGRADE
77443	DISCO MAX-3D GS8 UPGRADE
Industry Upgrade	
77469	INDUS-GRAPH GS8 UPGRADE
77466	INDUS-3D GS8 UPGRADE
Graphic Upgrade	
77465	GRAPHIC-3D GS8 UPGRADE
CAD only Upgrades*	
77448	DISCOCAD-DISCOVERY GS8 UPGR
77447	DISCOCAD-DISCMAXCAD GS8 UPGR
77450	DISCOCAD-INDUSCAD GS8 UPGR
77449	DISCOCAD-GRAPHCAD GS8 UPGR
77433	DISCMAXCAD-DISCMAX GS8 UPGR
77434	DISCMAXCAD-GRAPHCAD GS8 UPGR
77468	INDUSCAD-INDUSTRY GS8 UPGR
77467	INDUSCAD-GRAPHCAD GS8 UPGR
77464	GRAPHCAD-GRAPHIC GS8 UPGR
77432	3DCAD-3D GS8 UPGRADE

Gravostyle™ 8 & Laserstyle™ 8 Options	
General options	
77993	3 MONTHS FULL FUNCTIONS FREE
77345	DEDICACE OPTION GS8
77348	FONT PACK 1 OPTION GS8
77349	FONT PACK 2 OPTION GS8
77350	FONT PACK 3 OPTION GS8
77351	FONT PACK 4 OPTION GS8
77353	PERSO PACK OPTION GS8
77354	PHOTOSTYLE OPTION GS8
Discovery	
77342	2D FILLING BY COLOR OPT GS8
77344	BRAILLE OPTION GS8
77346	FONT EDIT+POINT MODE OPT GS8
77352	LONG PLATE OPTION GS8
77356	SCANNING / VECTOR OPTION GS8
77359	UPGRADE #OF MACHINES OPT GS8
Discovery Max options	
77344	BRAILLE OPTION GS8
77346	FONT EDIT+POINT MODE OPT GS8
77352	LONG PLATE OPTION GS8
77340	TEXT ON CURVE OPTION GS8
77359	UPGRADE #OF MACHINES OPT GS8
Industry options	
77342	2D FILLING BY COLOR OPT GS8
77343	BAR CODE OPTION GS8
77344	BRAILLE OPTION GS8
77346	FONT EDIT+POINT MODE OPT GS8
77355	PROFESSIONAL NESTING OPT GS8
77356	SCANNING / VECTOR OPTION GS8
77358	UID OPTION GS8
77359	UPGRADE #OF MACHINES OPT GS8

Gravostyle™ 8 & Laserstyle™ 8 Options	
Graphic options	
77341	2.5 D+INTAGLIO OPTION GS8
77343	BAR CODE OPTION GS8
77344	BRAILLE OPTION GS8
77482	CAM LASER OPTION GS8
77347	FONT EDITOR OPT GS8 GRAPHIC
77357	SEALS OPTION GS8
77358	UID OPTION GS8
77359	UPGRADE #OF MACHINES OPT GS8
3D options	
77343	BAR CODE OPTION GS8
77344	BRAILLE OPTION GS8
77347	FONT EDITOR OPT GS8 GRAPHIC
77355	PROFESSIONAL NESTING OPT GS8
77357	SEALS OPTION GS8
77358	UID OPTION GS8
77359	UPGRADE #OF MACHINES OPT GS8

Laserstyle™ 8 Upgrades	
77452	DISCO-DISCO MAX LS8 UPGRADE
77457	DISCO-INDUS LS8 UPGRADE
77455	DISCO-GRAPH LS8 UPGRADE
77998	DISCO-3D LS8 UPGRADE
77445	DISCO MAX-GRAPH LS8 UPGRADE
77997	DISCO MAX-3D LS8 UPGRADE
77470	INDUS-GRAPH LS8 UPGRADE
77996	INDUS-3D LS8 UPGRADE
77995	GRAPH-3D LS8 UPGRADE

Bridges from Laserstyle™ 8 to Gravostyle™ 8	
77428	DISCO LS8-GS8 BRIDGE
77429	DISCO MAX LS8-GS8 BRIDGE
77431	INDUS LS8-GS8 BRIDGE
77430	GRAPH LS8-GS8 BRIDGE
77994	3D LS8-GS8 BRIDGE

*Gravostyle™ also exists in a CAD only version:

- without CAM
- without printer output
- without machine control

Gravograph España

Avda. Valgrande 14, nave 21
28108 - Alcobendas (Madrid)
Tel: +34 91 733 70 21
Fax: +34 91 314 72 55
info@gravograph.es